

# Blitzortung.org

## A low cost Time of Arrival Lightning Location Network<sup>1</sup>

Egon Wanke, Düsseldorf, Germany



blitzortung@gmx.org

August 18, 2010

## 1 Introduction

A lightning discharge emits radio frequency energy over a wide range of frequencies. When high currents occur in previously ionized channels during cloud-to-ground flashes, the most powerful emissions occur in the VLF range. VLF (very low frequency) refers to radio frequencies in the range of 3 kHz to 30 kHz. An essential advantage of low frequencies in contrast to higher frequencies is the property that these signals are propagated over thousands of kilometers by reflections from the ionosphere and the ground.

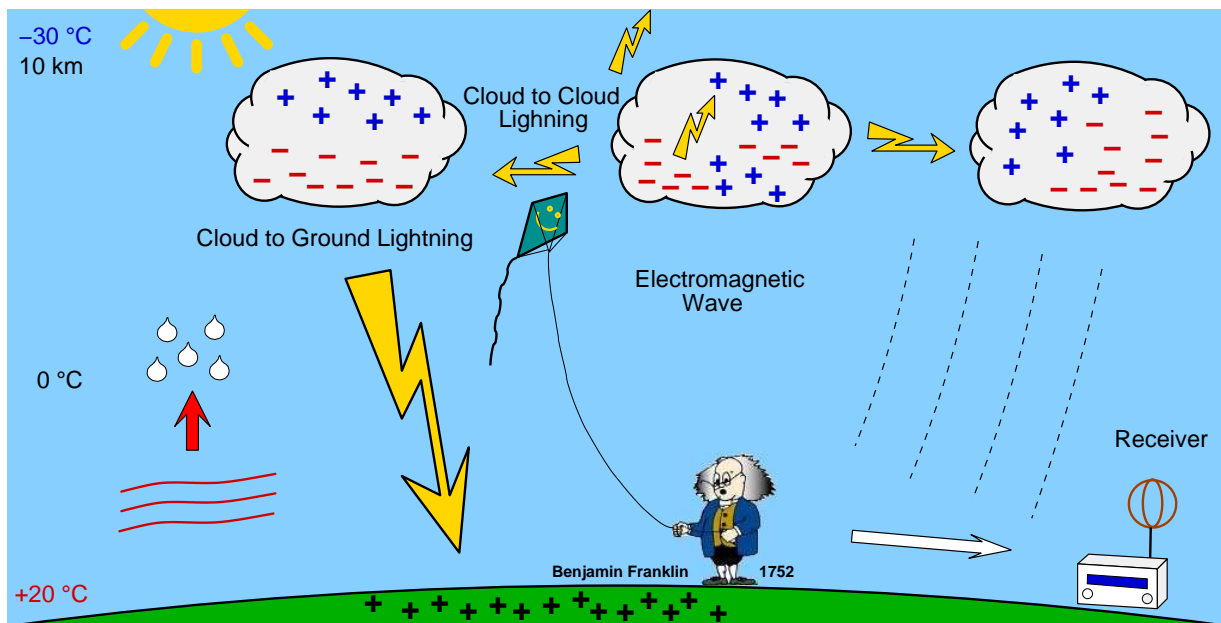

Figure 1: How lightning discharges arise.

<sup>1</sup>This document is still under development. If you have any comments to improve it, or if you find typos, please write a note to the author. It is not allowed to publish this document or excerpts of it on other websites than those of Blitzortung.org.

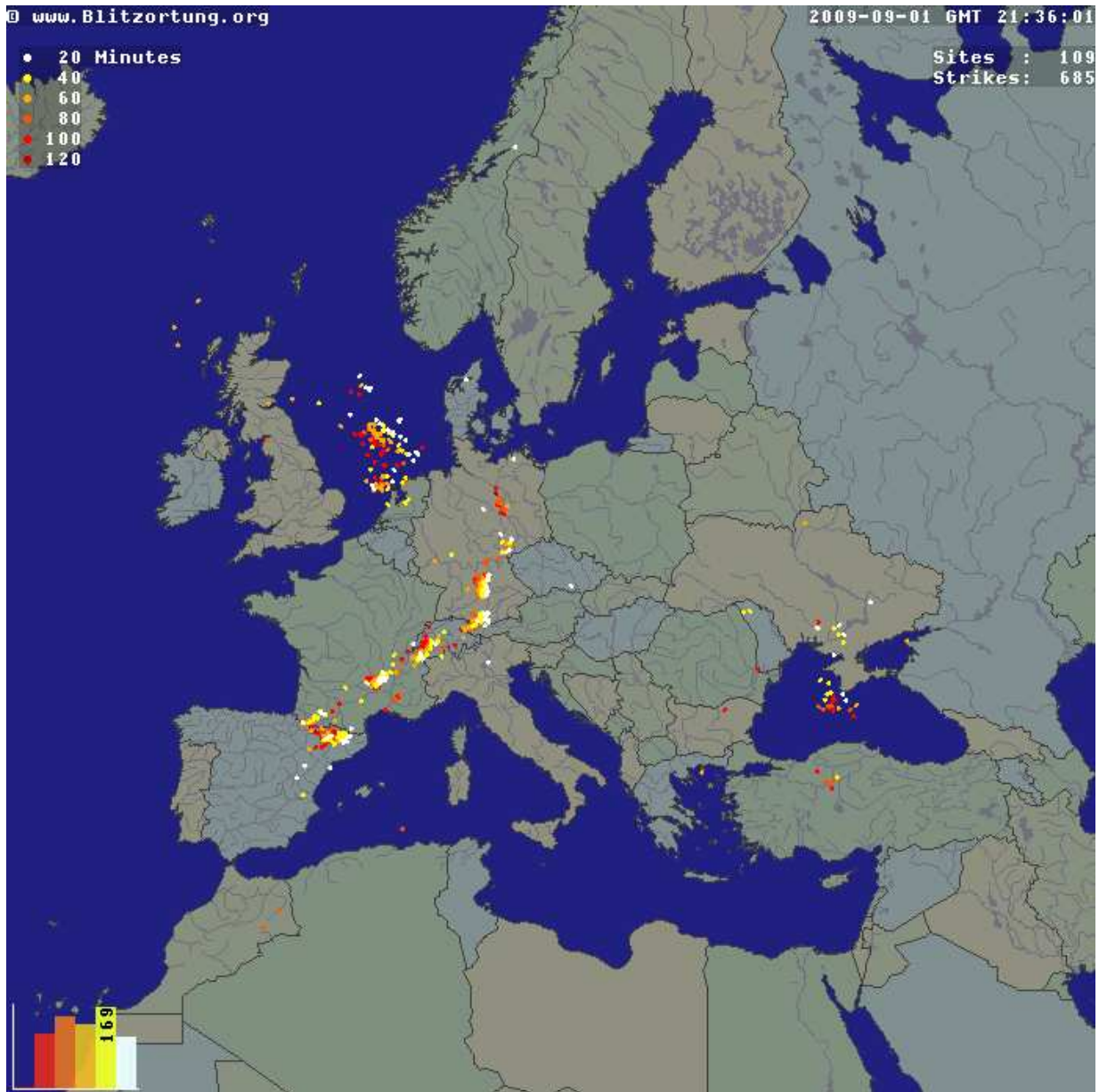

Figure 2: Lightning map of Europe at Blitzortung.org.

The lightning location network Blitzortung.org consists of several VLF lightning receiver sites and one central processing server. The sites transmit their data in short time intervals over the Internet to the server. Every data sentence contains the precise time of arrival of the received lightning strike impulse ("sferic") and the geographic position of the site. With this information from all sites the exact positions of the discharges are computed. The sferic positions are made available in raw format to all sites that transmit their data to our server. The site owner can use the raw data for all non-commercial purposes. The lightning activity of the last two hours is additionally displayed on several public maps recomputed every minute.

Blitzortung.org is a community of site operators who transmit their data to the central server, programmers who develop and/or implement algorithms for the location or visualization of sferic positions, and people who assist anyway to keep the system running. There is no restriction on membership. There is no fee and no contract. All people who keep the network in operation are volunteers. If a site stops pooling its data, the server stops providing the access to the archive of sferic positions for that site.

The aim of the project is to accomplish a low budget lightning location network based on a high number of sites spaced close to each other, typically separated by 50 km - 250 km. The hardware you need to participate to the network consists of an orthogonal crossed VLF loop antenna, a VLF pre-amplifier, our evaluation board, a GPS receiver providing an 1PPS (one-pulse-per-second) signal, and a personal computer permanently connected to the Internet.

Every site only records the arrival times of lightning discharges. It is not possible to compute positions or at least directions with the data from one station. We need the data of several stations to compute strike positions. There is currently no software that enables you to set up a connection with other sites like the LR software of Frank Kooimann for the direction finding system. The computation of strike positions is currently only done by the central server. However, you are invited to contribute to the project by writing such software.

## 2 VLF antennas

Waves with a frequency between 3 kHz and 30 kHz have a length between 100 km and 10 km. An applicable antenna for these frequencies is a **small loop antenna** of size less than 1/10000 of the wavelength in circumference. Small loops are also called magnetic loops, because they are more sensitive to the magnetic component of the electromagnetic wave, and less sensitive to near field electric noises when properly shielded. If the loop is small with respect to the wavelength, the current around the antenna is nearly completely in phase. Therefore, waves approaching in the plane of the loop will cancel, and waves in the axis perpendicular to the plane of the loop will be strongest. This property will change if the loop becomes larger.

The electric field of the radio waves emitted by cloud-to-ground lightning discharges is mainly oriented vertically, and thus the magnetic field is oriented horizontally. To cover all directions (all-around 360 degree) it is advisable to use more than one loop. A suitable solution can be obtained by two orthogonal crossed loops as they are used for a direction finding system.

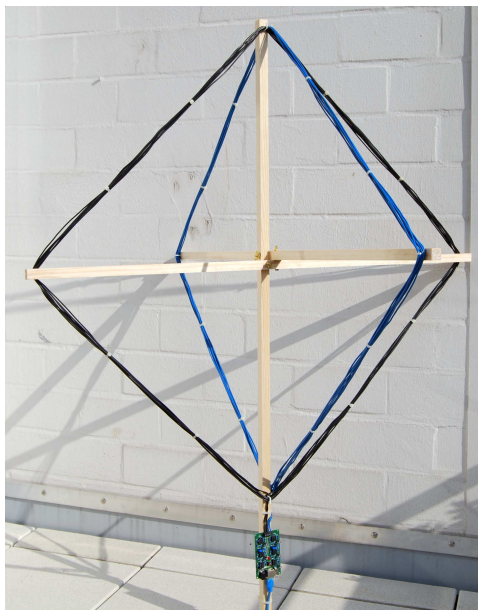

Figure 3: Two orthogonal crossed VLF loop antennas, 8 turns, diagonal size 1 m.

The electromagnetic signals of lightning discharges are not waves of a fixed frequency. The signals have more or less the form of an impulse and thus emits waves over a wide range of frequencies. Every of these impulses is unique and looks different. To measure the time of arrival of a lightning discharge, we need a wide-band receiving system, and not a tuned system. The antenna should be large to get a high voltage caused by the change of the electromagnetic field. If the loop consists of more than one winding, the wire placed side by side forms a capacitance. Thus, every loop antenna without any tuning capacitor

is already an oscillating system. However, the own resonance frequency should be as high as possible such that we can easily suppress these frequencies by a low-pass filter. Note that you should strictly avoid any additional tuning capacitor. The left picture of Figure 4 shows a signal received by two equal sized un-tuned loops antennas. These loops have no additional tuning capacitor. The own resonance frequency of the antenna is approximately 1000 kHz. The used pre-amplifier reduces frequencies of 1000 kHz by -72 dB. In the right picture of Figure 4 Loop B has a tuning capacitor of 1  $\mu$ F. Now the tuned frequency is approximately 10 kHz. Since lightning impulses often contain a lot of energy at 10 kHz, the tuned loop antenna only outputs unusable uniform waves of 10 kHz.

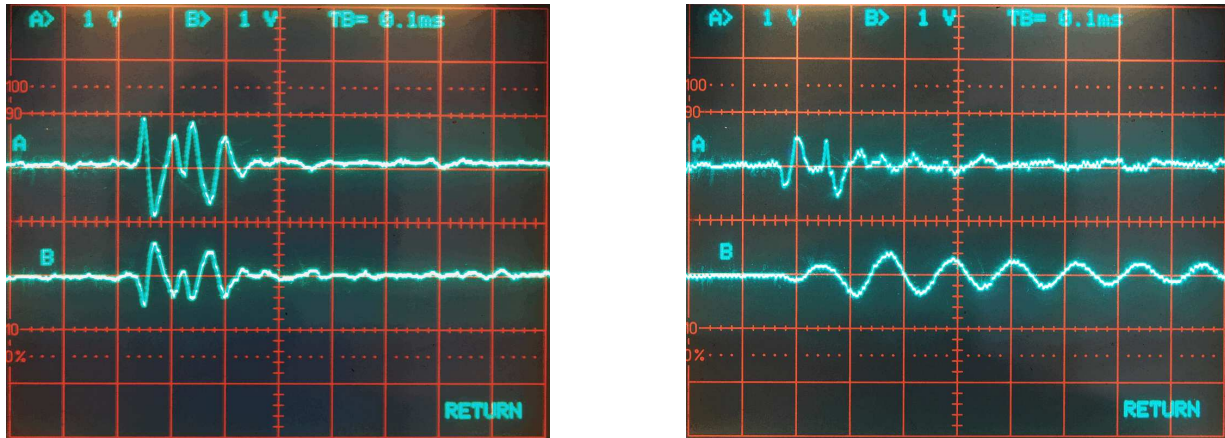

Figure 4: To the left, a signal received by two loop antennas without tuning capacitors. To the right, antenna B is tuned to approximately 10 kHz.

It is easy to set up a loop antenna for VLF frequencies by yourself. A useful construction manual can be found, for example, at [members.inode.at/576265](http://members.inode.at/576265). This document is written by Gerald Ihninger for the lightning radar project [www.lightningradar.net](http://www.lightningradar.net).

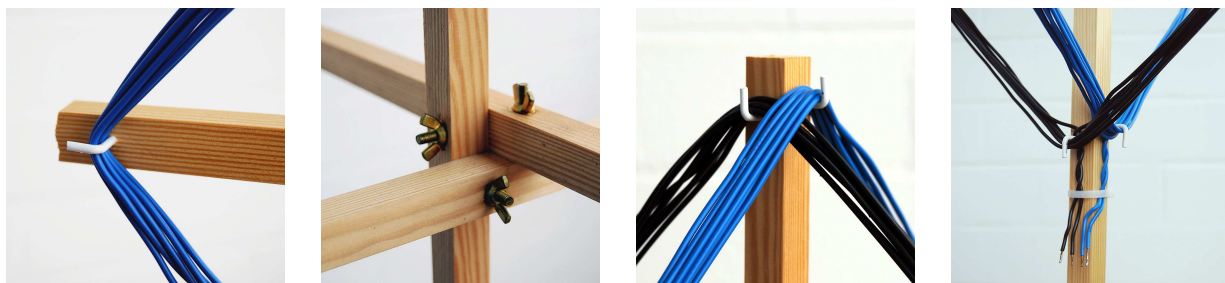

Figure 5: Assembling details of the loop antenna.

For a square loop antenna with a diagonal distance of 1 m and 8 turns of wire you need

- approximately 4 m of 20  $\times$  20 mm wooden coving,
- 2  $\times$  25 m cable with a single conductor of area 1.5 mm<sup>2</sup> (this corresponds to a diameter of 1.38 mm),

- 8 screw hooks,
- 3 screws/washer/wingnuts, and
- some cable ties.

The assembling takes about two hours. The price for the material is approximately 40 Euro in a German home improvement store.

The size of the antenna can extremely be reduced by using ferrite rods, but a ferrite rod antenna needs a higher number of turns to get the same voltage compared with the larger loop antenna. That is, the ferrite rod antenna has a lower resonance frequency than the larger loop antenna. This is one reason why the loop antennas are more adequate than small ferrite rod antennas. The resonance frequency of the ferrite rod antenna for wide-band VLF reception should not fall below 100 kHz. Suitable ferrite rod antennas can be obtained from [www.sfericsempfang.de](http://www.sfericsempfang.de).

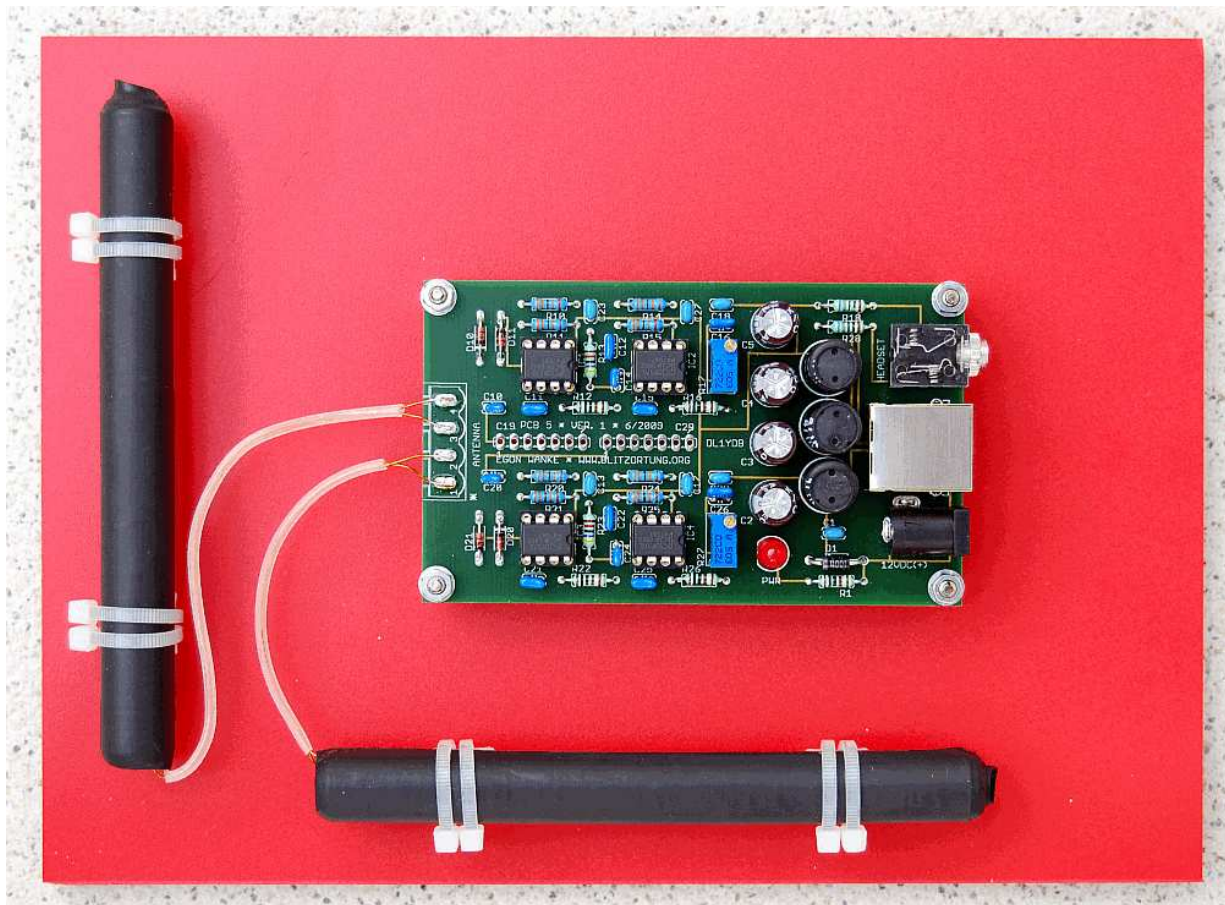

Figure 6: Two 12cm ferrite rod antennas mounted on a PVC board.

It is not necessary to align the two antennas to north/south and west/east. The ferrite rod antennas only have to be placed horizontally, because the magnetic field of radio waves

emitted by cloud-to-ground lightning discharges is mainly oriented horizontally. You have to strip the insulation of the copper enameled wires, before the blank copper wires can be soldered to the pre-amplifier board. The wires definitively have to be soldered to the board. It is not possible to tighten such thin wires sufficiently good with the screws of the terminal block. If you are using the ferrite rod antennas of [www.sfericsempfang.de](http://www.sfericsempfang.de), then one of the two copper enameled wire ends has a knot. Connect these wires to the capacitors C10 and C20, that is, connect them to the outer eyes of the terminal block.

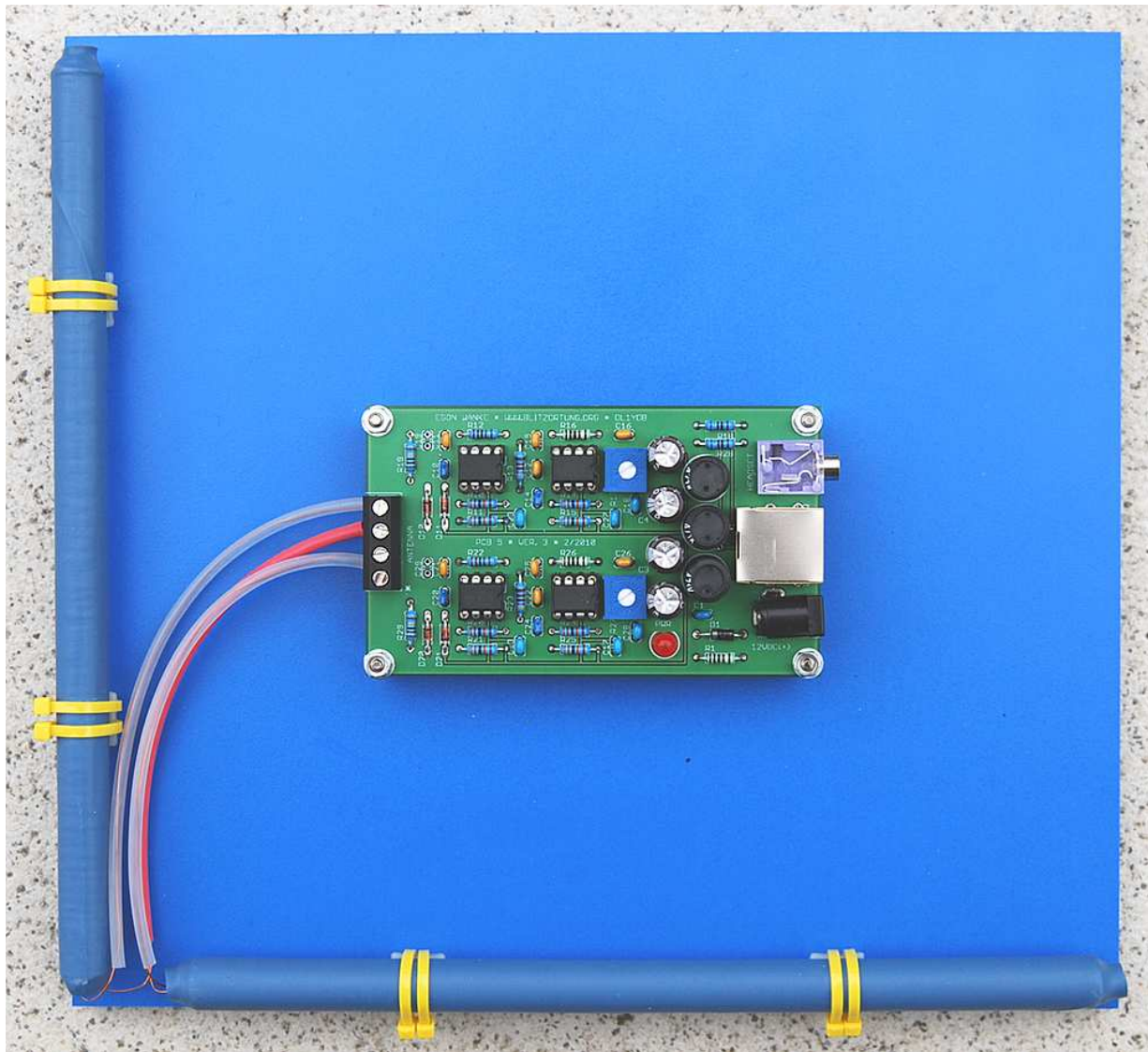

Figure 7: Two 20cm ferrite rod antennas mounted on a PVC board.



Figure 8: A 35 cm ferrite rod antenna in my hands.

It is also possible to use an **electrical antenna**, i.e., an antenna sensitive to the electric component of the electromagnetic wave. As already mentioned above, the electric field of the radio waves emitted by cloud-to-ground lightning discharges is mainly oriented vertically. That is, in the simplest case, the electrical antenna is a vertical wire directly connected to one channel of the pre-amplifier. Note that it is important that the wire is directly connected to the input of the pre-amplifier. Do not use coaxial connection cables. This could generate a phase shift which leads to an inaccurate time measurement. Figure 9 shows an example of a simple electrical antenna consisting of 1 meter cable. The amplification of the second channel should be switched off.

The advantages of an electrical antenna are the following. 1.) Since it receives signals from all horizontal directions, we need only one antenna instead of two antennas. 2.) The received signals are very clean and free of any resonances frequencies. Figure 10 shows a signal of a lightning discharge received by an electrical antenna (above) and received by a ferrite rod antenna (below). 3.) It is possible to determine the polarity of the lightning discharge, if the lightning discharge was not too far away. 4.) It is easy to construct for a very low price. However, an electrical antenna has also some disadvantages. 1.) It is very sensitive to field electric noises. 2.) It has to be placed outside or at least on an attic, and thus, conditions for lightning protection have to be respected.

The **ground** of the pre-amplifier and thus also the ground of the evaluation board should be connected to a large expanse of metal such as a safety hand rail around a roof. Note that the ground of the boards should never be connected to the ground wire of the





Figure 9: A wire of 1 meter length used as an electrical antenna.

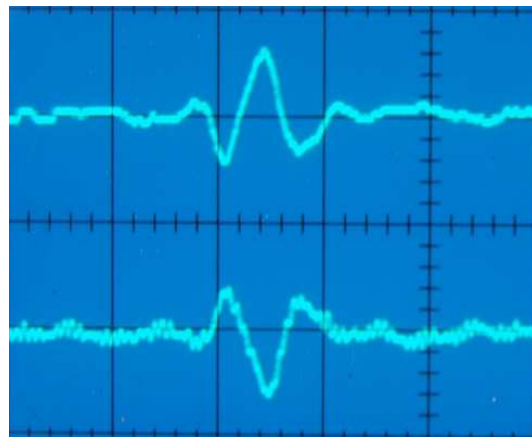

Figure 10: A signal of a lightning discharge received by an electrical antenna (above) and by a loop antenna (below).

electrical supply system. Usually the grounding is already given if the serial SUB-D plug is connected to the PC.

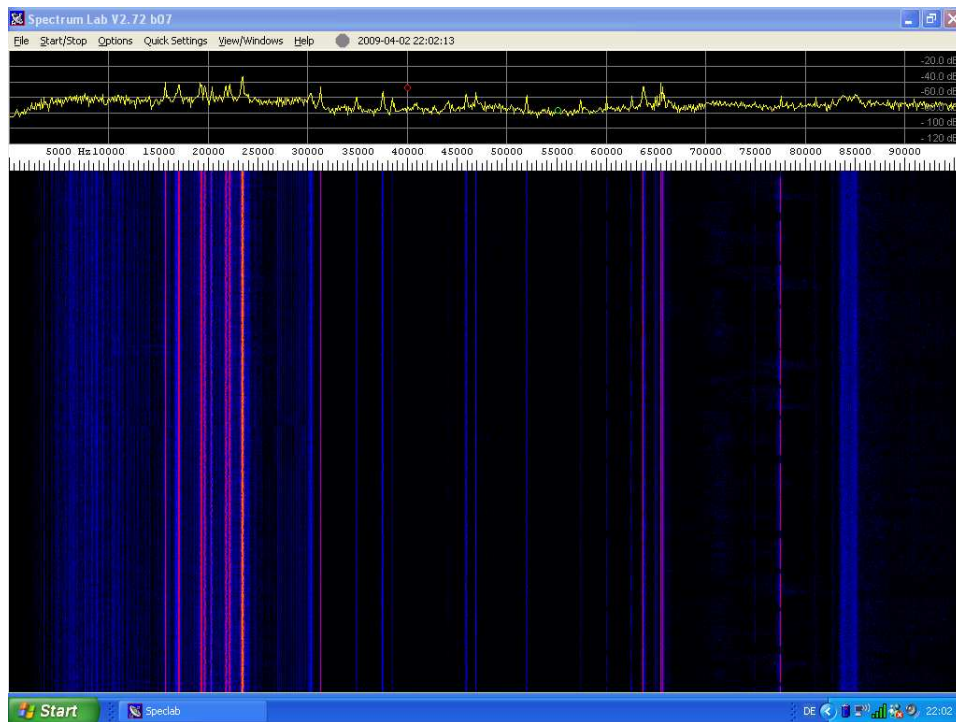

Figure 11: A spectrogram of the signal received by a 35 cm ferrite rod antenna.

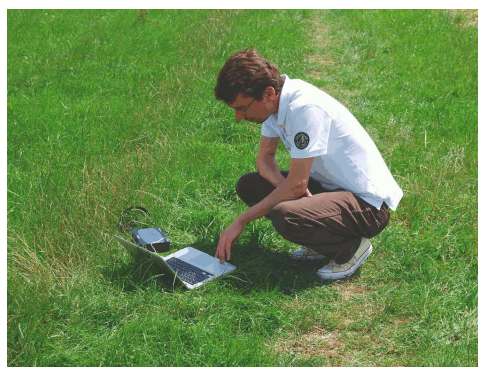

Figure 12: A quite location far away from electrical magnetic VLF noises.

### 3 VLF pre-amplifier

A VLF pre-amplifier can easily be realized by standard operational amplifiers (op-amps). The output of an op-amp is controlled either by negative feedback, which largely determines the magnitude of its output voltage gain, or by positive feedback, which facilitates regenerative gain and oscillation. Operational amplifiers have in general a high input impedance and a low output impedance.

The VLF pre-amplifier we need should use a first-order active low-pass filter with a cutoff frequency of approximately 15 kHz to 70 kHz determined by

$$f = \frac{1}{2 \cdot \pi \cdot R_1 \cdot C_1},$$

see for example Figure 14. The low-pass filter reduces the signal amplitude by half (about  $-6$  dB) every time the frequency doubles. The filter is mainly used to reduce the signals nearby the resonance frequency of the loop antenna. In general, every loop antenna with more than one turn has a resonance frequency depending on the capacity between the loop wires. It is also not desirable to use filter very high order, because filter of oversized order can generate a too high phase shift which could lead to an inaccurate time measurement. If you are using larger loop antennas or electrical antennas, you can choose higher cutoff frequencies than 15 kHz. The gain of the amplifier is determined by the voltage divider  $R_1/R_2$  and can be computed by  $1 + \frac{R_1}{R_2}$ . Table 1 shows some of the possible  $R_1/C_1$  pairs with a cutoff frequency of approximately 15 kHz/33 kHz/72 kHz and the corresponding gains with  $R_2 = 2.2\text{k}$  for one stage.

$R_1$	$C_1$	Cutoff frequency	Gain with $R_2 = 1\text{k}$
22 k	470 pF	15.4 kHz	11
47 k	220 pF	15.4 kHz	22
100 k	100 pF	15.9 kHz	46
22 k	220 pF	32.9 kHz	11
47 k	100 pF	33.8 kHz	22
100 k	47 pF	33.8 kHz	46
22 k	100 pF	72.3 kHz	11
47 k	47 pF	72.1 kHz	22
100 k	22 pF	72.3 kHz	46

Table 1:  $R_1/C_1$  pairs for the low-pass filter with a cutoff frequency of approximately 15 kHz/33 kHz/72 kHz.

The printed circuit board PCB 5 realizes a two channel two stage VLF pre-amplifier. For the sake of simplicity, the amplifier operates in single-supply mode with non-inverting attenuation, see Figure 13. The gain of each stage is approximately 22 ( $47\text{ k}/2.2\text{ k}$ ). The



Figure 13: The assembled pre-amplifier PCB 5 Version 4.

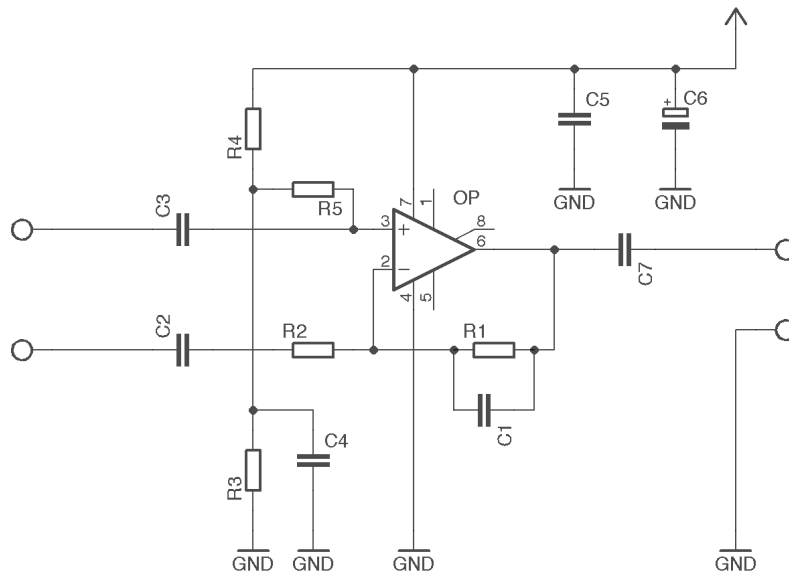

Figure 14: An amplifier stage in single-supply operation with non-inverting attenuation.

pre-amplifier circuit will be adjusted from time to time to improve its quality for our special application and to reduce the price. If you want to use your own pre-amplifier, please send us a circuit diagram. It is very important that you do not include delaying part like induction in the signal ways. The latest version of our pre-amplifier is 5.4. The

part list is shown in Table 2, the PCB layout is shown in Figure 15, and the complete circuit diagram is shown in Figure 16.





Operational amplifier	IC1, IC2, IC3, IC4	NE5534
LED, standard	PWR	LED 5mm (red)
rectifier diode	D1	1N4001
Resistor, metal film	R4-A, R9-A, R4-B, R9-B	330 K 
	R2-A, R3-A, R6-A, R7-A, R8-A, R2-B, R3-B, R6-B, R7-B, R8-B	47 K 
	R1, R12-A, R12-B	1 K 
	R5-A, R10-A, R5-B, R10-B	2.2 K 
Trimmer	R11-A, R11-B	50 K
Capacitor, electrolytic,	C2, C3, C4, C5	470 $\mu$ F/330 $\mu$ F
Capacitor, ceramic	C1, C9-A, C10-A, C13-A, C14-A, C17-A, C9-B, C10-B, C13-B, C14-B, C17-B	100 nF (104)
	C15-A, C15-B	22 nF (223)
	C7-A, C8-A, C12-A, C7-B, C8-B, C12-B	10 nF (103)
	C11-A, C16-A, C11-B, C16-B	220 pF (221)
Tuning Capacitors (do not use)	C6-A, C6-B	1nF (102)
Inductor, ferrite	L1, L2, L3	470 $\mu$ H/330 $\mu$ H

Table 2: The list of electronic parts for the VLF pre-amplifier version 5.4.

The DC jack can be used for power supply with positive polarization at the center. The power of the pre-amplifier can also be supplied by the evaluation board and vice versa. The voltage should not fall under 6 Volt and should not exceed 15 Volt. The series resistance R1 to the power control LED should be adjusted to the supplied voltage. For 12 Volt and a standard LED a series resistor between 330 and 2.2 K is adequate. You can also use a switching power supply without any problems, if you place it far away from the antennas.

The 3.5 mm jack socket can be used to connect a stereo headphone. This provides an easy and affective way to detect interfering devices and thus to find the best place for an undisturbed operation. Note that the headphone has to be unplugged during normal operation.

The output voltage of the pre-amplifier should be between  $-2.5$  Volt and  $+2.5$  Volt.

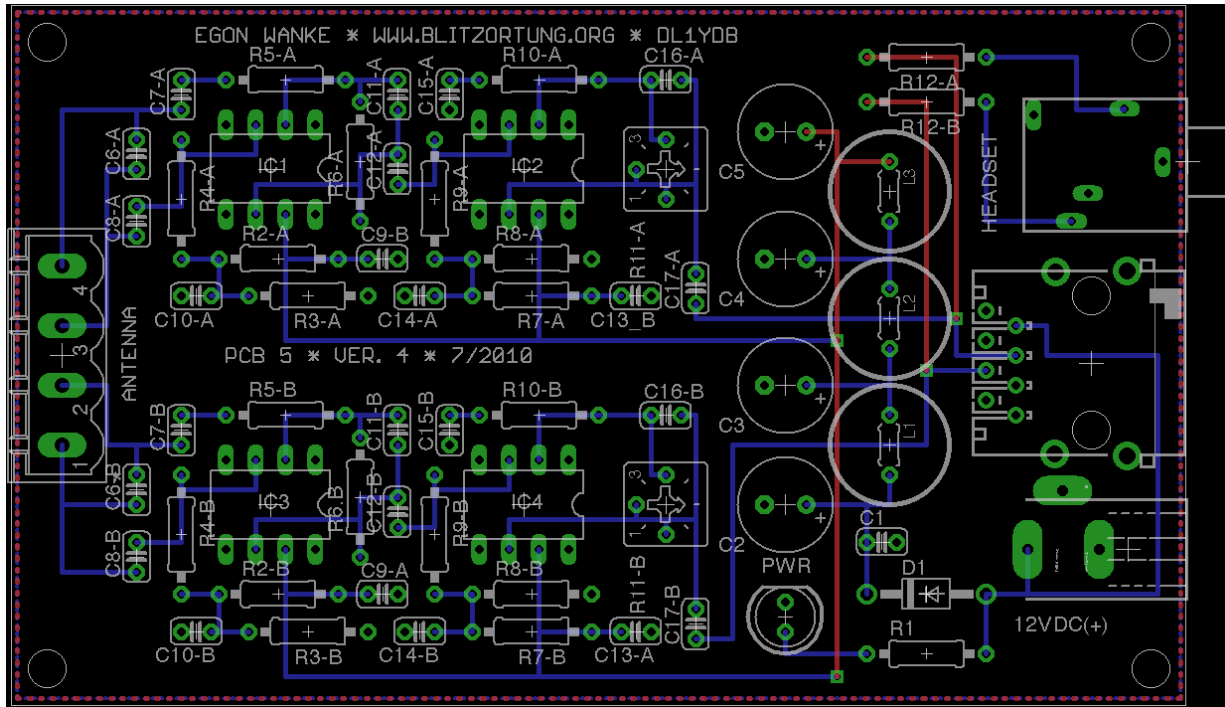

Figure 15: The layout of the VLF pre-amplifier PCB 5 Version 4.

These are the reference voltages of the analog digital converter on the subsequent evaluation board. In most cases, the board is used under the following circumstance: 12 V power supply, two square loop antennas (diagonal size 1 m) with 8 turns (wire 1.5 mm<sup>2</sup>) connected to the input, or two 20cm ferrite rod antennas. In these cases, you can turn both trimmers fully up. This yields the maximal amplification. If you have too much interferences, you should reduce the amplification by the 50k trimmers. You will reduce the amplification to the half by adjusting the trimmers to 25K, and to a fourth by adjusting them to 12.5K.

The tuning capacitors C6-A and C6-B should only be used if the resonance frequency of the loop antenna is accidentally tuned at a long wave radio station. Do not use these capacitors with ferrite rod antennas or electrical antennas. The resonance frequency of a loop antenna should not fall below 1kHz.

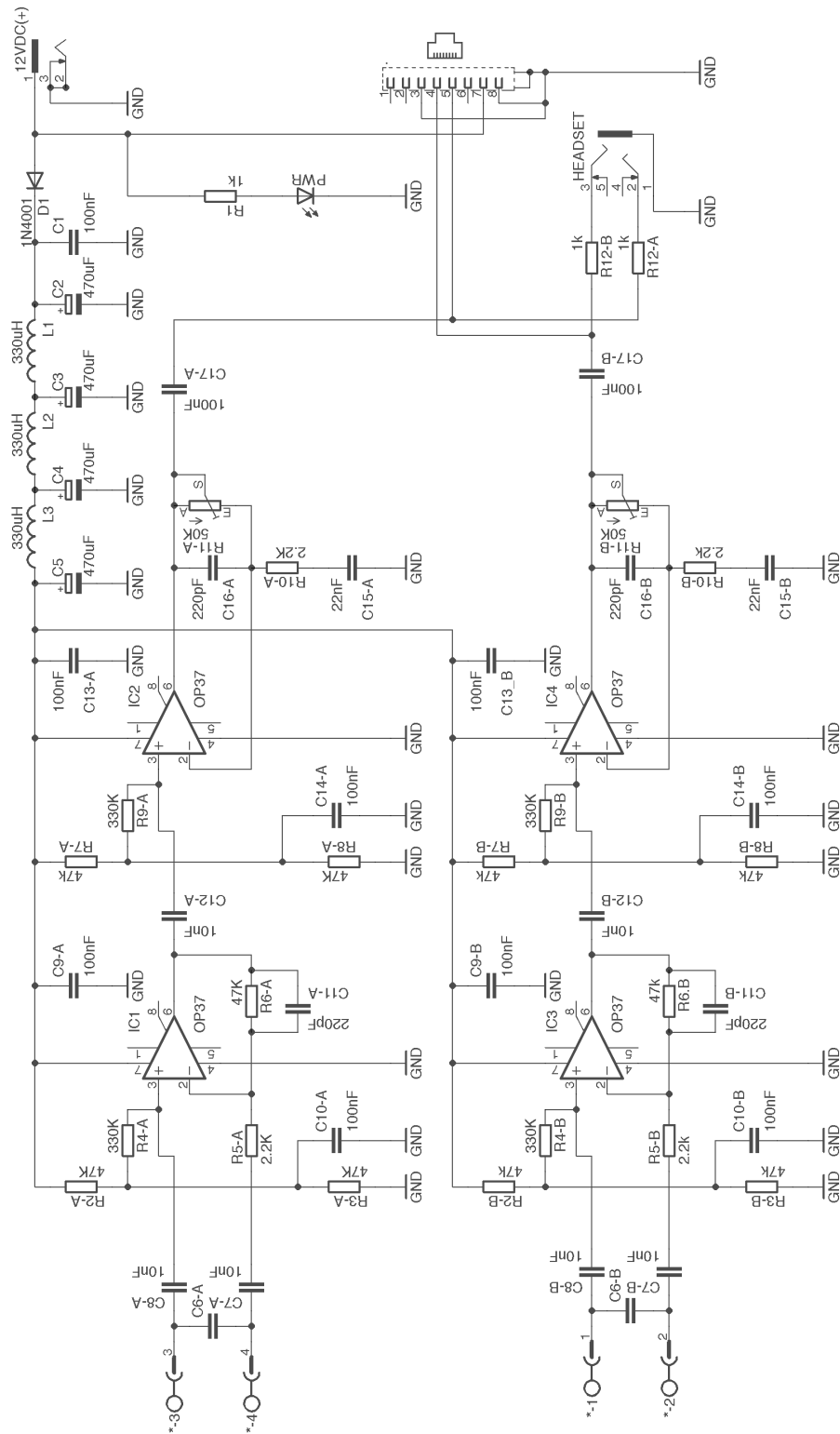

Figure 16: The circuit diagram of the pre-amplifier board PCB 5 Version 4.

## 4 The evaluation board

The heart of the evaluation board is an Atmel 8-bit AVR micro controller ATmega644 running with a clock frequency of 20 MHz. The board also contains two 10-bit analog-to-digital converters AD7813 that operate in high speed mode, i.e., not powered down between conversions. In this mode of operation the converters are capable to provide a throughput of 400 ksps. Unfortunately, the ATmega644 is not able to process the data as fast as provided. Therefore, we use only 8-bit conversions with a throughput of 320 ksps.

The other integrated circuits of the board are a quad comparator LM339 to activate the analog-to-digital conversion, if the input signal exceed a threshold, and a dual driver/receiver MAX232 that converts the TTL input level into RS-232 output level and vice versa, if necessary.

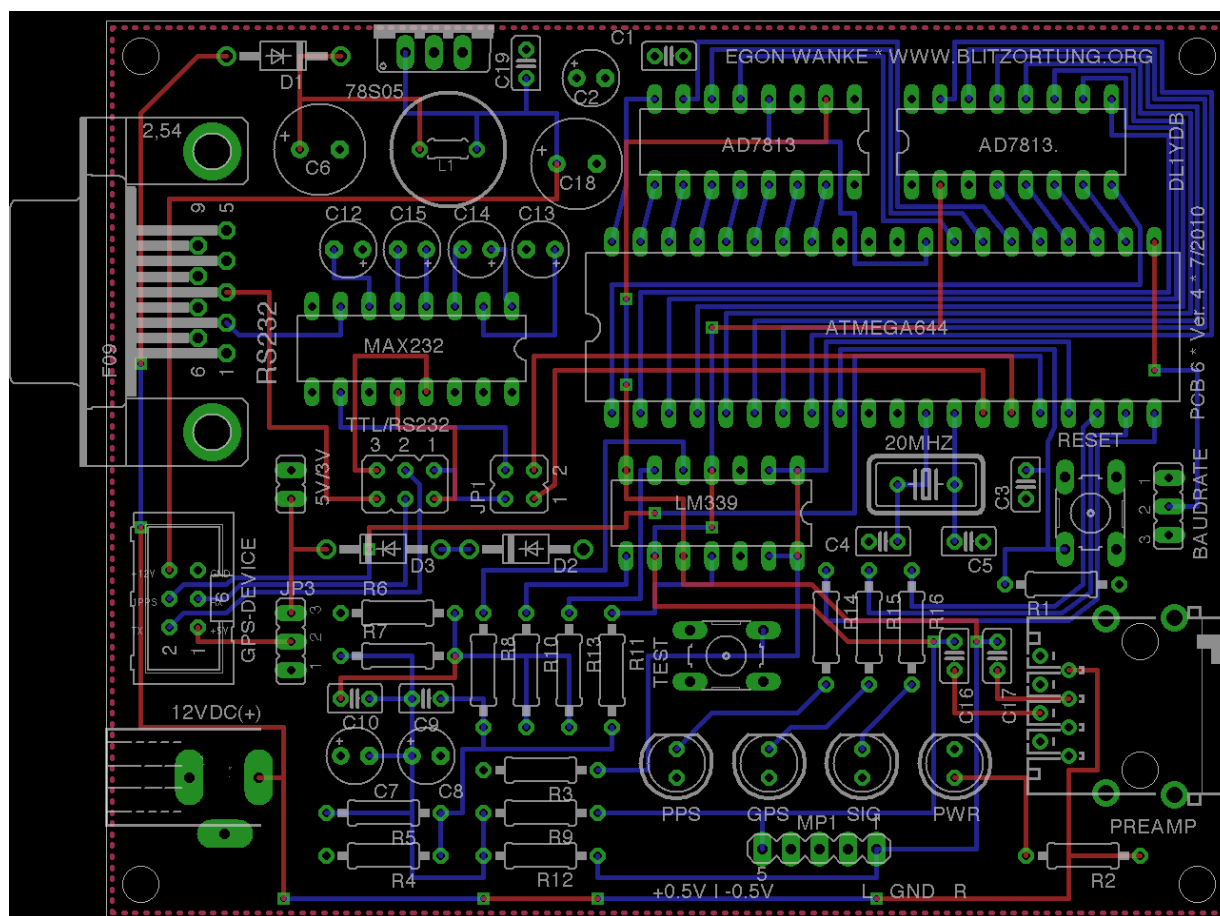

Figure 17: The layout of the evaluation board PCB 6 Version 4.

An internal timer of the controller is initialized to run with clock frequency divided by 8 and will be triggered by the rising edge of the 1PPS signal from the GPS receiver. The counter difference between two 1PPS signals is approximately 2500000, thus one counter unit corresponds to 400 ns. If the signal from the receiver reaches the thresholds of  $\pm 0.45$



Volt, the controller captures the counter and starts the analog-to-digital conversion. Then the controller takes 64 bytes of every AD converter. This corresponds to a sampling duration of  $200\mu s$ . Additionally, the controller permanently reads the GPRMC and GPGLA data sentences of the GPS receiver to know the time, the geographic position, the altitude, and the number of used satellites.





Resistor, metal film	R1, R3, R4, R6, R8, R9, R10, R11, R12, R13	10 K 
	R5, R7	2.2 K 
	R2, R14	1 K 
	R15, R16	330 Ohm 
Capacitor, electrolytic radial, pitch 2.5 mm	C6, C18	470 $\mu F$ /330 $\mu F$
	C2	100 $\mu F$
	C7, C8, C12, C13, C14, C15	4.7 $\mu F$
Capacitor, ceramic pitch 5 mm	C1, C3, C9, C10 C16, C17, C19	100 nF (104)
	C4, C5	15 pF
	Inductor, ferrite	L1
rectifier diode	D1, D2, D3	1N4001
LED, standard	PWR LED	LED 5 mm (red)
	SIG LED	LED 5 mm (yellow)
	GPS LED	LED 5 mm (green)
	PPS LED	LED 5 mm (blue)
Quartz crystal	Q1	20 MHz
Voltage regulator	IC1	78S05
Comparator	IC2	LM339
Driver/receiver	IC3	MAX232
Analog-to-digital converter	IC6, IC7	AD7813
Micro controller	IC8	ATmega644 20PU

Table 3: The part list for the evaluation board PCB 6 Version 4.

The pre-amplifier and the evaluation board can be connected by a 1-to-1 shielded cat cable via the RJ45 jacks. This allows to use the same power supply for both boards.

As for the pre-amplifier, the DC jack is used for power supply with positive polarization at the center. The voltage should not fall under 6 Volt and should not exceed 15 Volt.

If the power supply is connected to the board, the (red) PWR LED will glow and the other three LEDs will blink four times. The (yellow) SIG LED flashes every time the

controller outputs a data sentence containing strike signal information. The (blue) 1PPS LED is blinking every time the GPS provides a 1PPS signal. This should be every second. The (green) GPS LED starts blinking if the board gets data sentences of GPS device with the correct baud rate (4800 baud or 19200 baud). To find the right baud rate, just switch the green BAUDRATE jumper and push the reset switch. If the GPS device is on track, that is, if the GPRMC data sentence contains status “A”, the green GPS LED will glow permanently. This is usually the case when the GPS device receives at least one satellite. If the green GPS LED is off, you should move the GPS to a more adequate place. The LED series resistances R2, R16, R17, and R20 have to be adjusted to the supplied voltages. For standard LEDs, the series resistor R2 (12 V) should be chosen between 1 k and 2.2 k, the series resistors R16, R17, and R20 (5 V) should be chosen between 330 Ohm and 1 k. If the board is powered on, the three LEDs SIG, GPS and 1PPS are blinking some times. This just indicates that the controller is running.

The measuring point MP1 provides at Pin 1 and Pin 5 the two signals from the pre-amplifier. Pin 3 of MP1 is the ground of the board.

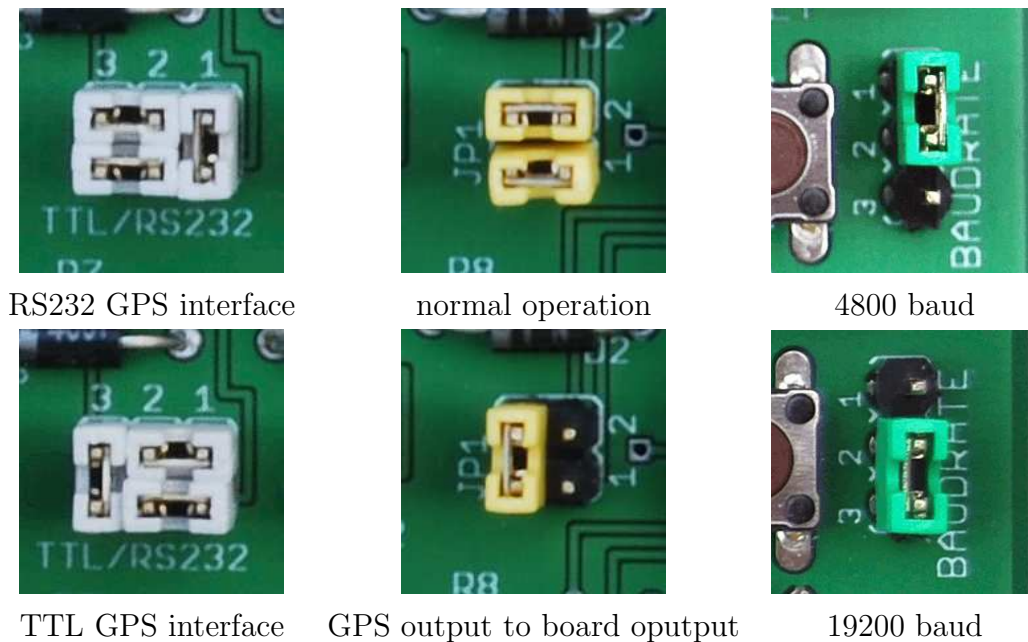

Figure 18: Jumper settings.

The jumpers have the following meaning, see Figure 18 and 19.

1. The TTL/RS232 Jumper allows to select the signal level of the serial GPS interface. The jumper setting shown in the upper (lower) figure of the GPS interface provides RS232 level (TTL level, respectively).
2. Jumper JP1 can be used to bypass the serial connection to/from the controller. The setting shown in the upper figure connects the output of the GPS receiver with the

input of the controller and the output of the controller with the output of the board. This is the normal operation. The setting shown in the lower figure separates the controller from the serial stream. It connects the output of the GPS receiver with the output of the board. This setting allows to monitor the output of the GPS receiver at the serial RS232 interface of the board.

3. The 5V3V Jumper allows to connect 3 Volt (if the 3V/5V Jumper is set) or 5 Volt to Pin 1 of the GPS connector header. This allows to supply 3 Volt or 5 Volt power to the GPS device.
4. The Baudrate Jumper allows to switch the serial speed between 4800 baud and 19200 baud. The jumper setting shown in the upper (lower) figure is for 4800 baud (19200 baud, respectively).

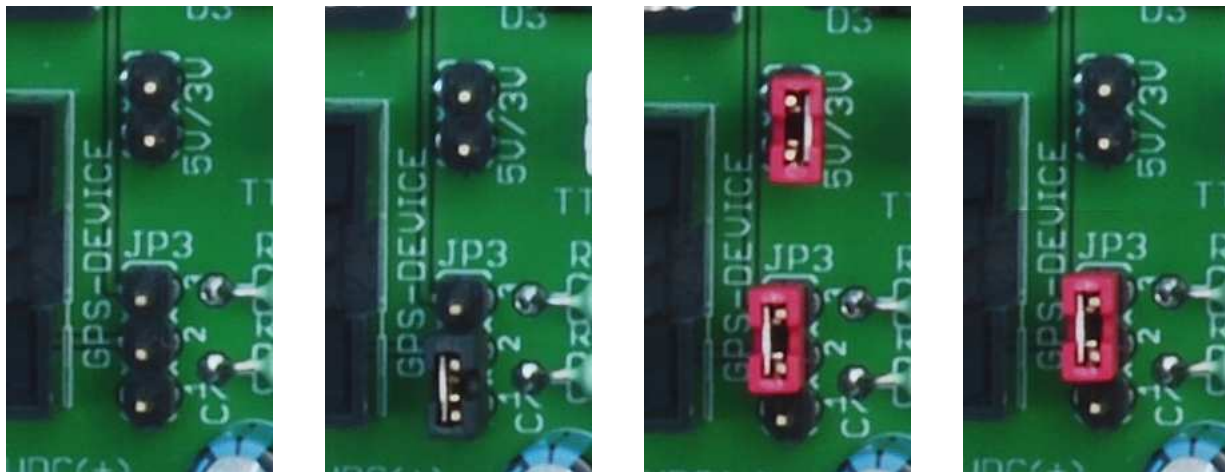

Pin 1: open

Pin 1: ground

Pin 1: 5 Volt

Pin 1: 3.5 Volt

Figure 19: Jumper settings.

The 6 way straight header wire-to-board connector is used for the GPS connection, see also Section 5 how to connect common GPS receivers to the board. The pin assignment is shown in Table 4. The power supply for the GPS receiver can be connected to Pin 6 if it works with the same voltage as the evaluation board. It can be connected to Pin 1 if it needs only 3 Volt or 5 Volt. Note that the voltage regulator 78S05 could extremely heat up, if the current of the GPS receiver exceeds 100 mA.

The 9-way Sub-D plug is the connector for the serial RS232 interface, 4800 baud or 19200 baud, 1 stop bit, no parity. The input to the board is passed to the GPS receiver. The output of the board provides data formatted NMEA 0183, Version 2.0. There are two types of sentences starting with BLSEC and BLSEQ, see Table 5 and 6. A BLSEC sentence is output every second, a BLSEQ sentence is output every time the amplitude exceeds the threshold voltage of the comparators.

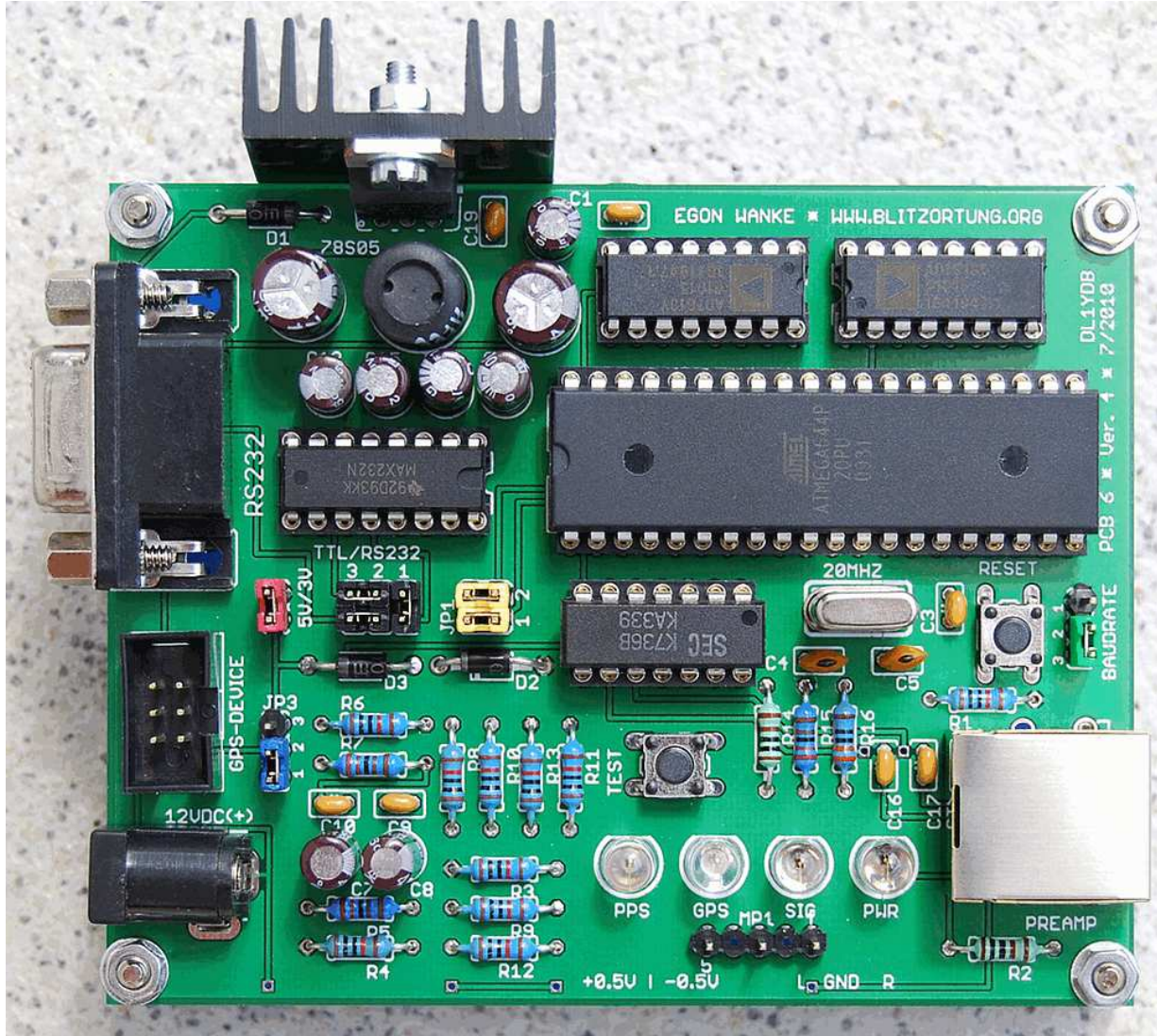

Figure 20: The assembled evaluation board PCB 6 Version 4.

Header pin	Description
1	3 Volt, 5 Volt, Ground, open
2	serial output
3	serial input
4	1PPS input
5	GND
6	V+ before voltage regulator (+12 Volt)

Table 4: Pin assignment of the connector for the GPS receiver.



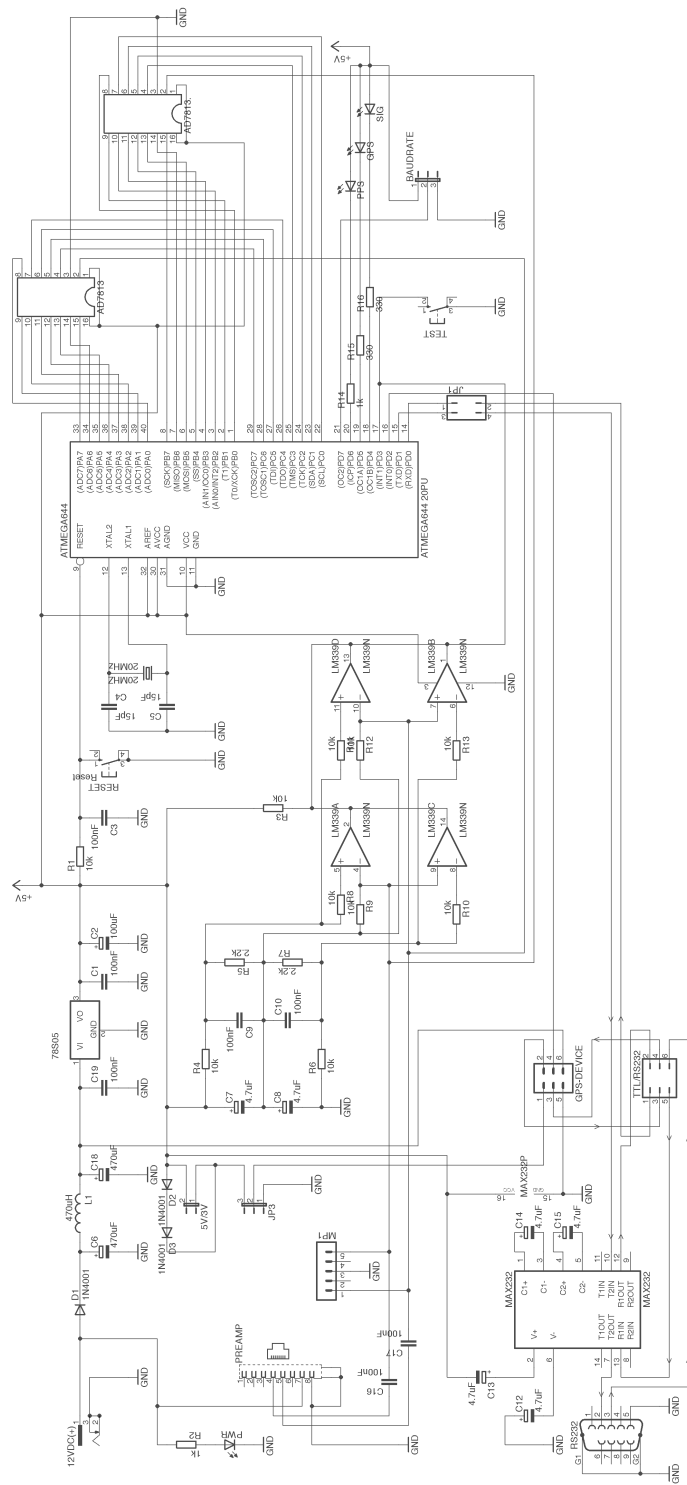

Figure 21: The circuit diagram of the evaluation board PCB 6 Version 4.









Garmin 16 HVS



AQTIME VP-200T



Fortuna U2

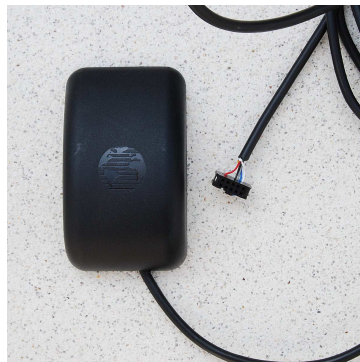

Garmin 35 HVS/LVS

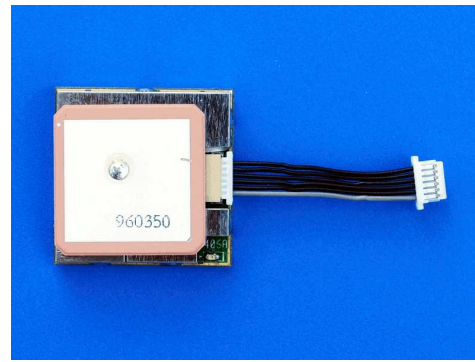

EM-406A

Figure 22: Some GPS devices providing a 1PPS output.

Color	Description	Header of PCB 6.x
yellow	power on/off switch	1
white	serial input RS232	2
blue	serial output RS232	3
grey	1PPS output	4
black	power ground	5
red	+12 Volt	6

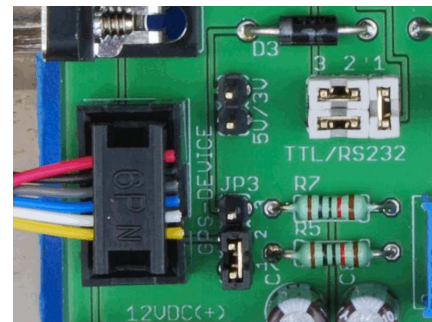

Figure 23: A Garmin 16/35 HVS connected to the evaluation board.

power on cycle. By default, the Baud rate is set to 4800 Baud.

The **Garmin 35-LVS** differs from the Garmin 35-HVS only in the voltage of the power supply. The LVS version is designed to operated from a voltage of 3.6 Volt to 6 Volt. Its current consumption is approximately 150 mA. Here we recommend to use a separate voltage regulator, or a separate power supply. Both can easily be connected to the board if the red wire of the GPS is connected to Pin 1 of the straight header. Then at Pin 2 of

```

$PGRMO,GPGGA,1*20
$PGRMO,GPGSA,0*35
$PGRMO,GPGSV,0*22
$PGRMO,GPRMC,1*3D
$PGRMO,GPVTG,0*25
$PGRMO,PGRMM,0*32
$PGRMO,PGRMT,0*2B
$PGRMO,PGRME,0*3A
$PGRMO,PGRMB,0*3D
$PGRMCE*0E
$PGRMC,,51.5,,,,,,,,,5,,2,4,*67

```

Table 9: Initialization strings for Garmin GPS devices.

Jumper J3 the power supply for the GPS device can be connected, Pin 1 is the Ground of the board. If you are using a sufficient large cooling device, you can also connect Pin 1 to the 5 Volt power of the evaluation board provided after the voltage regulator, see Figure 24 to the left, or to 3.6 Volt obtained from 5 Volt by two additional series 1N4001 diodes, see Figure 24 to the right.

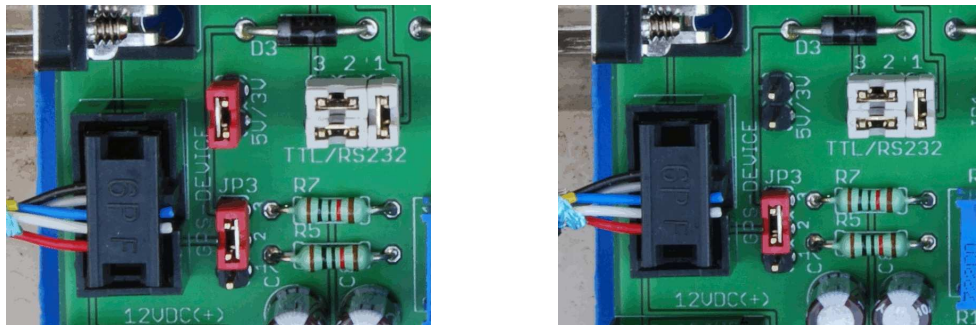

Figure 24: A Garmin 35-LVS connected to the evaluation board using 5 Volt power supply to the left and 3.6 Volt power supply to the right.

Note that both Garmin 35 GPS devices sometimes produce some low acoustic noises which seems to be not worryingly.

The **AQTIME VP-200T** is a timing GPS receiver and antenna in a compact weather-proof enclosure for time-measuring application. It outputs a 1PPS pulse with  $\pm 100ns$  tolerance. It has also a flexible power supply of 8 Volt to 40 Volt. The power consumption is typically 1.1 W. The device can also easily be supplied by the 12 Volt power supply of the evaluation board. It comes with 5 meters of cable ending with a 9-ways SUB-D plug for the serial interface, a DC plug for power supply, and a phono plug for the 1PPS signal.

The wires we need for the connection to the evaluation board have the following colors (if the plugs are cut off) and can be connected to the following pins of the straight header.

Color	Description	Header
green	serial input RS232	2
white	serial output RS232	3
blue	1PPS output	4
black	power ground	5
red	+12 Volt	6

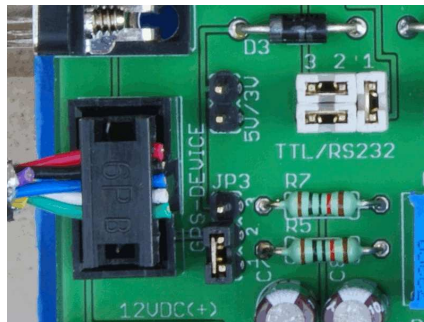

Figure 25: A AQTIME VP-200T connected to the evaluation board.

The AQTIME VP-200T provides the 1PPS signal with a duration of 100 ms by default. The initialization by the tracker program switches off the data sentences GPGLL, GPGSA, GPGSV, GPDTM, and PGZDA. The data sentences GPRMC and GPGGA are switched on for an output of every second. Unfortunately, the AQTIME VP-200T only supports a data transfer rate of 4800 Baud.

```
$PFEC,GPint,GGA01,GLL00,GSA00,GSV00,RMC01,DTM00,VTG00,ZDA00*52
```

Table 10: Initialization strings for San Jose Navigation GPS devices.

The **Fortuna U2-PS/2** is a small GPS mouse using a SiRF-II chip-set. The body is not completely water resistant, and thus not adequate for outdoor mounting. It comes with 2 meters of cable ending in a female 6-ways Mini-DIN plug. Although the GPS module provides the 1PPS output with a duration of 100 ms, the signal is not connected to the cable. This can be changed by a simple modification. Note that there are several versions of the Fortuna U2. Some of them provide an USB interface (Fortuna U2-USB). These receivers can not be used in connection with the evaluation board. Newer versions use a SiRF-III chip-set. We do not know whether the SiRF-III module also provide the 1PPS output. If somebody has find out this, please give us some feed back such that we can include this information here.

To modify the Fortuna U2 we have to open die housing by taking out the two screws on the backside. Then we can remove the cap and will find a soldered copper box, see Figure 26 to the left. The cap contains two slices that makes the base of the device magnetic, see Figure 26 to the right. These two slices usually fall down when opening the housing. If we open the copper box we will find the GPS module. We have to move the yellow wire from Pin 2 to Pin 9, see Figure 26 in the middle. After that we can solder up the copper box. An easy way to mount the cap with the two magnetic slices is the following. Attach

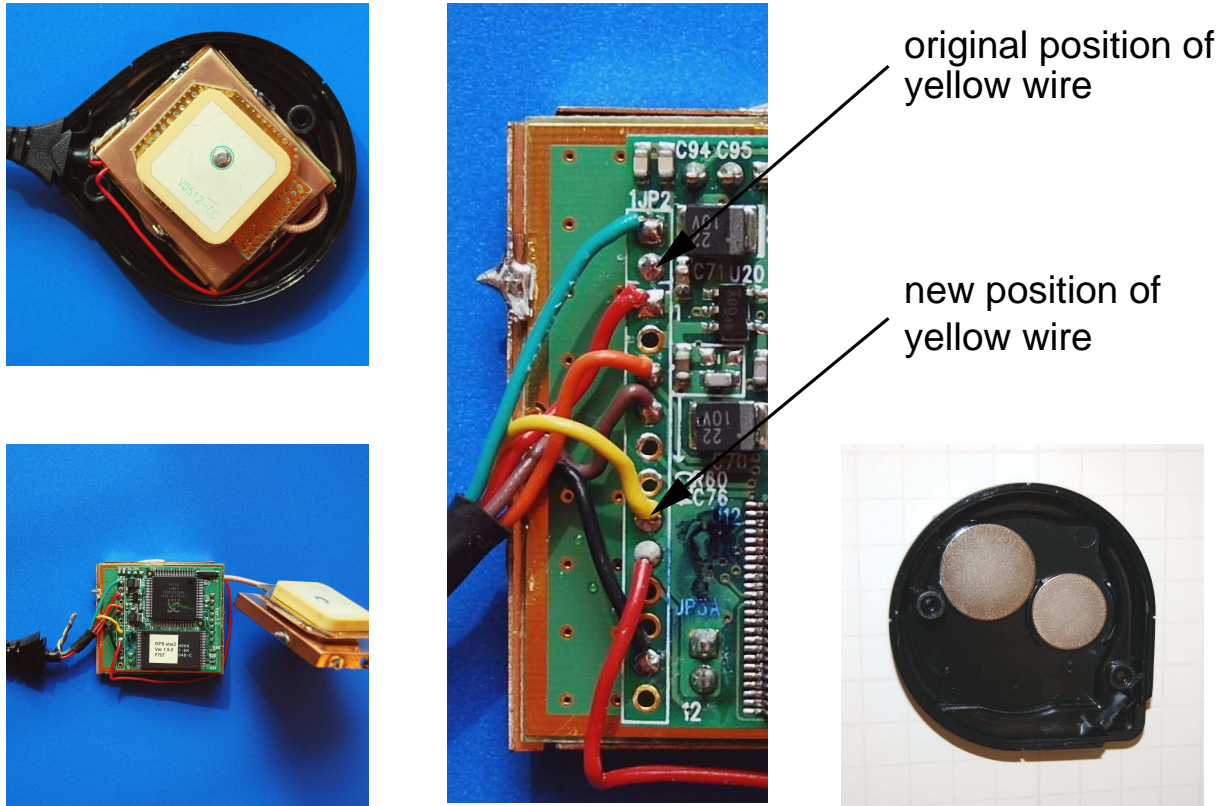

Figure 26: The modification of the Fortuna U2.

the cap on a metal board by the magnetic slices from inside. Then insert the module and push the housing to the cap. After the modification the 6-way female Mini-DIN plug has the following pin assignment. Note that the information about the pin assignment at the folder enclosed to the original package of the Fortuna U2 is definitely wrong!

Color	Description	Mini-DIN	Header
orange	serial input RS232	4	2
brown	serial output RS232	2	3
yellow	1PPS output	1	4
black	ground	3	5
red	+5 Volt	6	6

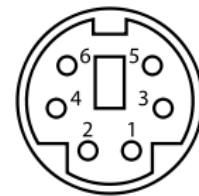

Figure 27: The the female Mini-DIN connector from the front.

The initialization by the tracker program switches off the data sentences GPGLL, GPGSA, GPGSV, GPMSS, GPDTM, and PGZDA. The data sentence GPRMC and GPGGA will be switched on for an output by every second. The communication speed of the serial interface is 4800 Baud by default, but the initialization switches the communication speed to 19200 Baud.

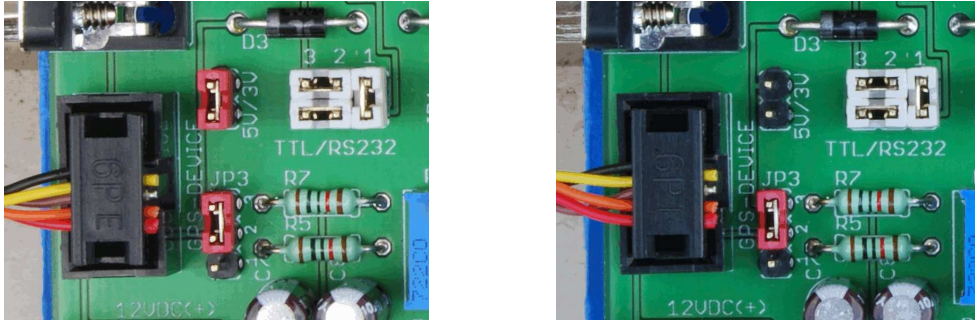

Figure 28: The Fortuna U2 connected to the evaluation board using 5 Volt power supply to the left and 3.6 Volt power supply to the right.

```

$PSRF103,00,00,01,01*25
$PSRF103,01,00,00,01*25
$PSRF103,02,00,00,01*26
$PSRF103,03,00,00,01*27
$PSRF103,04,00,01,01*21
$PSRF103,05,00,00,01*21
$PSRF103,06,00,00,01*22
$PSRF103,08,00,00,01*2C
$PSRF100,1,19200,8,1,0*38

```

Table 11: Initialization strings for SiRF GPS devices.

The power supply is 5 Volt, the current consumption is approximately 90 mA. If the temperature of the voltage regulator exceeds 40 degree, it should be mounted on a larger cooling device. The GPS device can alternatively be supplied by a separate voltage regulator or power supply, respectively, similar to the Garmin 35 LVS.

For connecting the GPS device with the evaluation board, you can either cut of the Mini-DIN connector from the cable and connect the wires directly to the jack, or, if you do not like this destructive solution, you can use an extension cable. Unfortunately, many of these GPS mice are some years old such that the internal backup battery is empty. In these cases, the initialization, the selection of the data sentences and the Baud rate of 19200, falls down to the default Baud rate of of 4800 Baud, whenever the power supply will be interrupted.

The **EM-406A** is a GPS module using a SiRF-III chip-set. The sensitivity of this device is extremely high, sensivity -159dBm. It can also be used at a window side. Since the module has no housing, it should be protected elsewise. Figure 29 show two example for an integration of the module into housings of other GPS devices.

Following the manufacturers' specifications, it operates with a voltage of 4.5 Volt to 6.5 Volt and consumes approximately 44 mA, but the module also works fine with 3.6 Volt.



Figure 29: An EM-406A module embedded into the housing of a Fortuna U2, to the left, and embedded into a housing of a Navilock NL-303P, to the right.

The module provides a very short 1PPS output with a duration of  $5 \mu s$ . The initialization is the same as for the Fortuna U2 using the SiRF-II chip-set. A backup battery keeps all the settings during a power down. The module also contains a LED indicator for GPS fix or not fix. The default Baud rate is 4800 baud. There is one main difference between the EM-406A and all other GPS devices discussed in this section. The serial connection uses TTL signal level (0V/2.85V) and not RS-232 signal level (+3V/-3V). In this case, we have to change the jumper setting for the TTL/RS232 jumper as shown in Figure 32.

The EM-406A module comes with a 6-pin interface cable that can be used to connect a longer connection cable. For our embedding of the EM-406A to the housing of a Navilock NL-303P, the black wire connected to Pin 1 at the module connector was changed to Pin 6. The ground signal is then still available via pin 5 of the module connector.

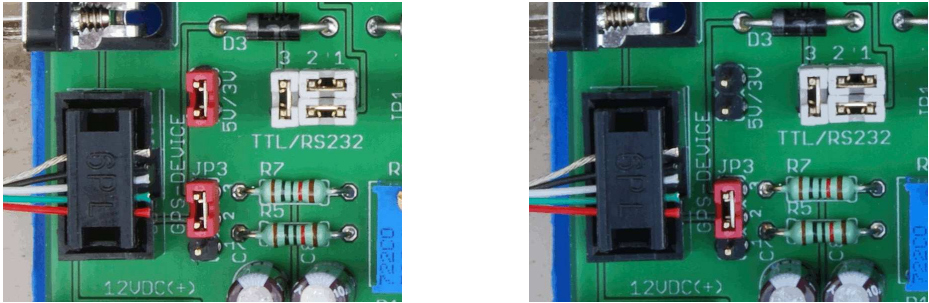

Figure 30: EM-406A connected to the evaluation board using 5 Volt to the left and 3.6 Volt to the right. Please observe the reverse setting at the TTL/RS232 jumper.

There are several further GPS devices that can be connected to the board. For example, the Garmin 17-HVS can be handled in the same way as the Garmin 16-HVS. The RoyalTek RGM-2000 can be modified similar like the Fortuna U2.

GPS	Description	Header of PCB 6.x
1	ground	5
2	+5 Volt	1
3	serial input TTL	3
4	serial output TTL	2
5	ground	
6	1PPS	4

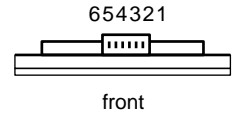
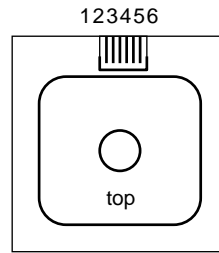

Figure 31: Pin assignment of the EM-406A module.

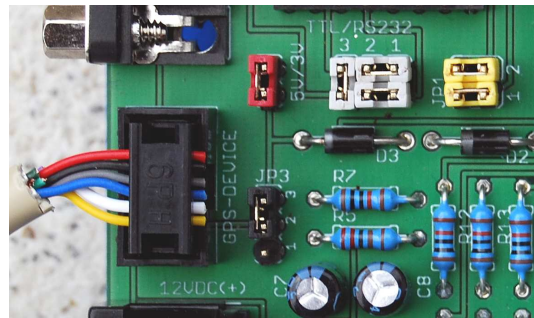
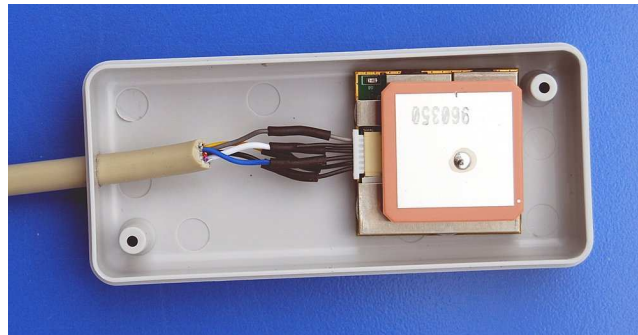

Figure 32: An EM-406A module embedded into a plastic housing.

## 6 Data upload

The data from the evaluation board will be uploaded to our computing server by a *tracker program*. There are two versions of tracker programs, one for computers running Linux operating system and one for computers running Windows operating system. The official tracker program for Linux is written by Egon Wanke. The official tracker program for Windows is written by Edmund Korffmann. You can download these tracker programs from your login page.

To upload data with the Windows tracker program you have to insert your username and password in the "Password" menu. The "Interval" menu allows you to set the time span the tracker will try to establish a connection to our server. It should be set to 20 seconds. Activating the "Auto" flag will cause the tracker to start up automatically after the PC will restart. If the "Minimize" flag is set the tracker window will disappear from the desktop. The "Log" flag activates log file output, and the "Adj. System Time" option allows to synchronize the local clock by the GPS time.

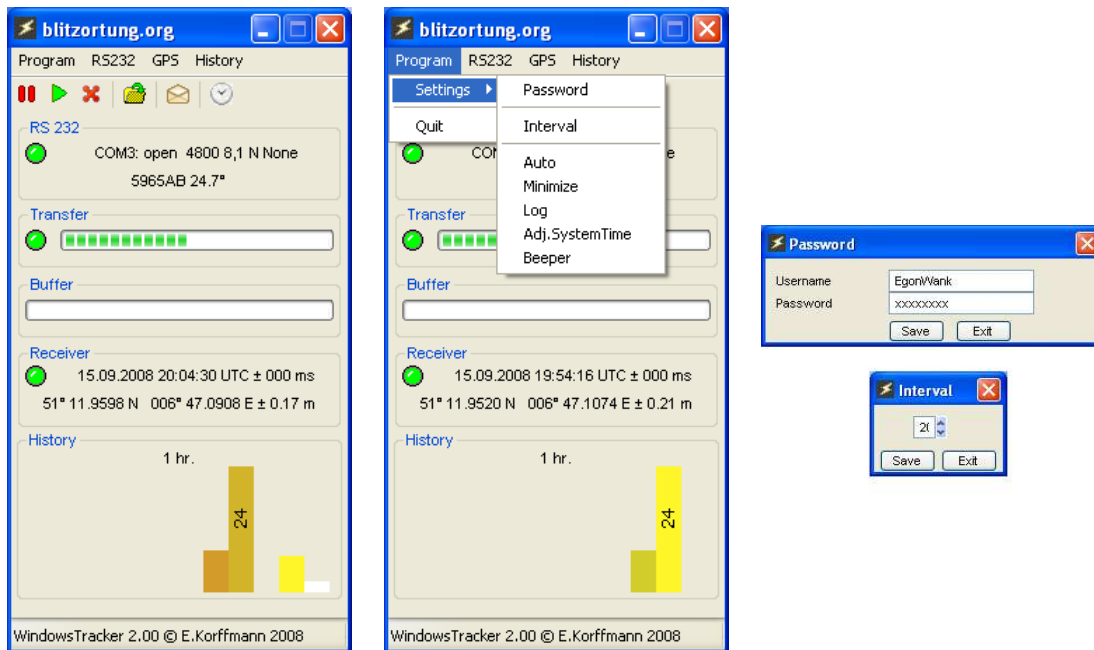

Figure 33: Some screen dumps of the tracker program for Windows.

The serial interface of the evaluation board works by default with 4800 Baud, 1 stop bit, no parity. The GPS menu can be used to initialize the GPS device. If you need an additional initialization strings for your special GPS device, please contact us. The "History" menu allows to change the scaling for the strike number visualization. Here the complete time span and the number of bars can be specified. The height of a bar corresponds to the number of strikes in the corresponding time interval.



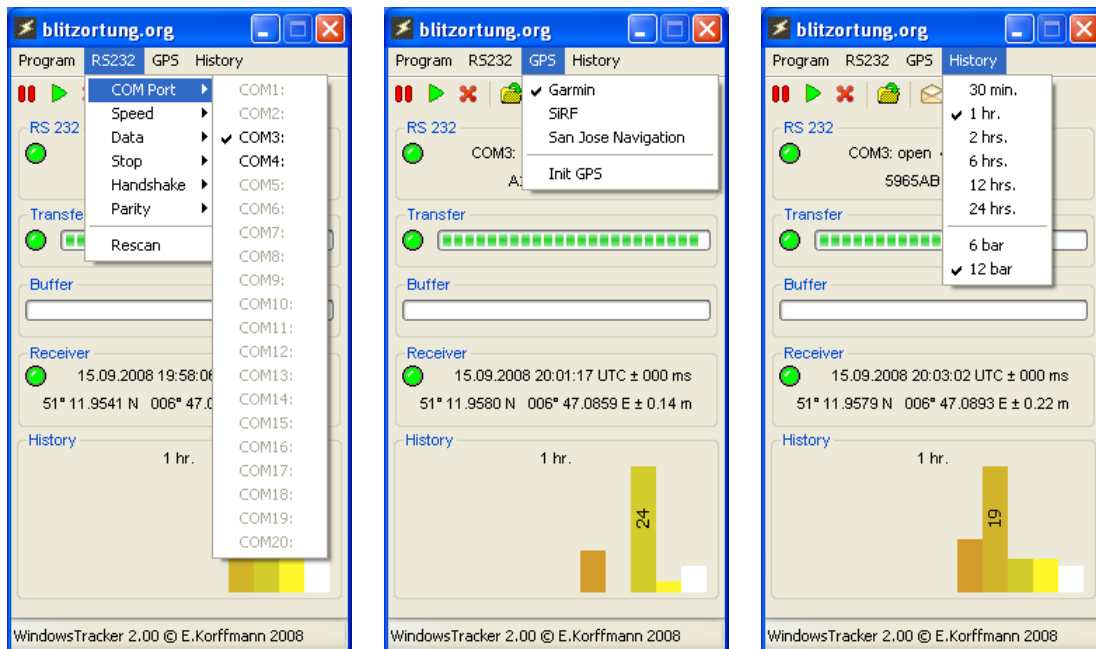

Figure 34: Some screen dumps of the tracker program for Windows.

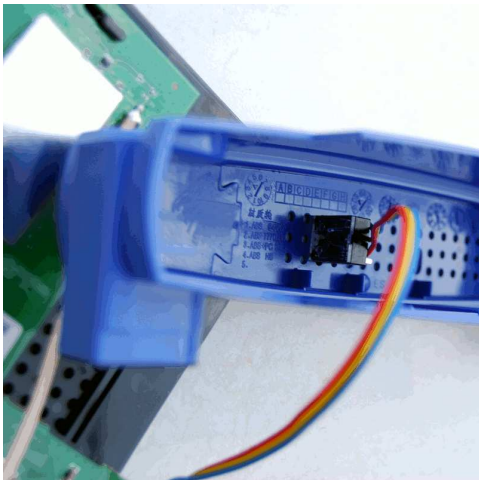

Figure 35:

## 7 Location accuracy

The TOA (time of arrival) lightning location technique is based on hyperbolic curve calculations. The emitted radio signals of a lightning discharge are traveling with the speed of light. These are approximately 300000 kilometers per second. Each received signal is time-stamped at the receiving sites. The time-stamp differences are used for hyperbolic curve generation. The point of intersection of all hyperbolic curves defines the location of the source of the radio signal, see Figure 36. The computed position is then be assumed to be the location of the lightning stroke. At least 4 sites are needed to define always a unique intersection of the hyperbolic curves. With more than four receiving sites reporting the same signal there is some redundant information available to improve the accuracy and to verify the performance.

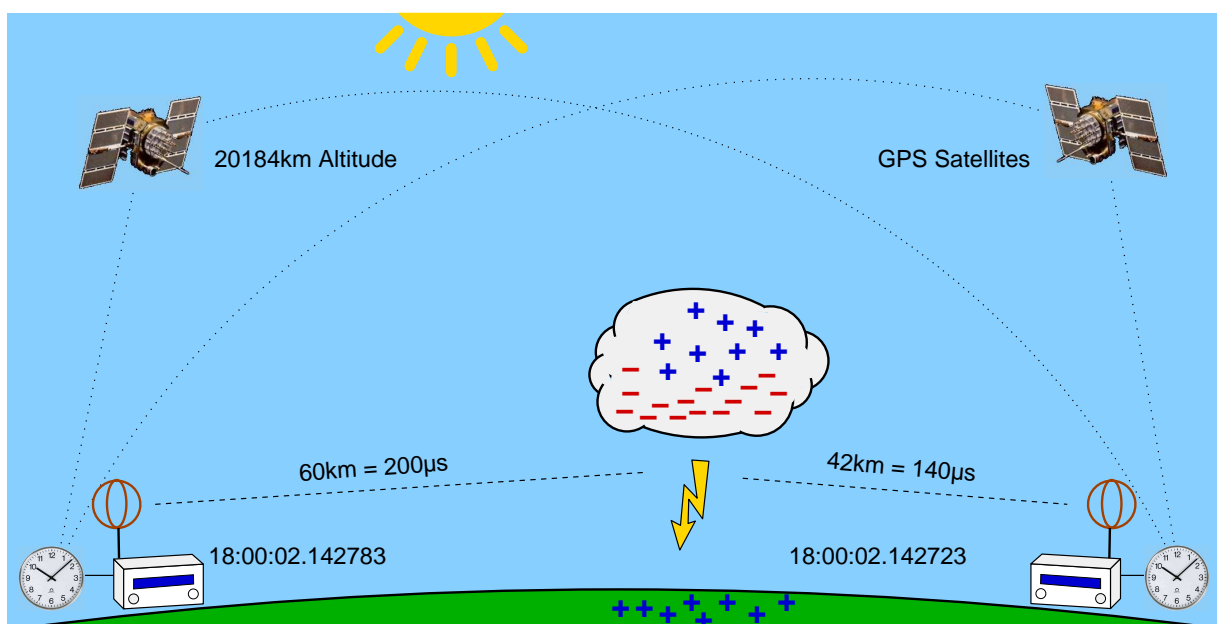

Figure 36: The site to the left receives the signal  $60\mu s$  later than the site to the right, because the lightning discharge is 18 km more far away from the site to the left than from the site to the right.

A time difference of, for example,  $\pm 100$  microseconds corresponds to a distance difference of  $\pm 30$  kilometers. That is, if site  $A$  receives the same signal 100 microseconds earlier than site  $B$ , the corresponding hyperbolic curve is defined by the set of all points that are 30 kilometers near to site  $A$  than to site  $B$ . Assume the time stamps have an accuracy of  $\pm 1\mu s$  and there are four sites arranged such that their positions define a square. If the signal source is exactly in the middle of the square, then the deviation of the computed position to the real source of the signal is greater than  $\pm 300m \cdot \sqrt{2} = 424m$ . It can be much greater if the source of the signal is outside the square.

The main problem of the TOA lightning location is to assign a received signal a unique

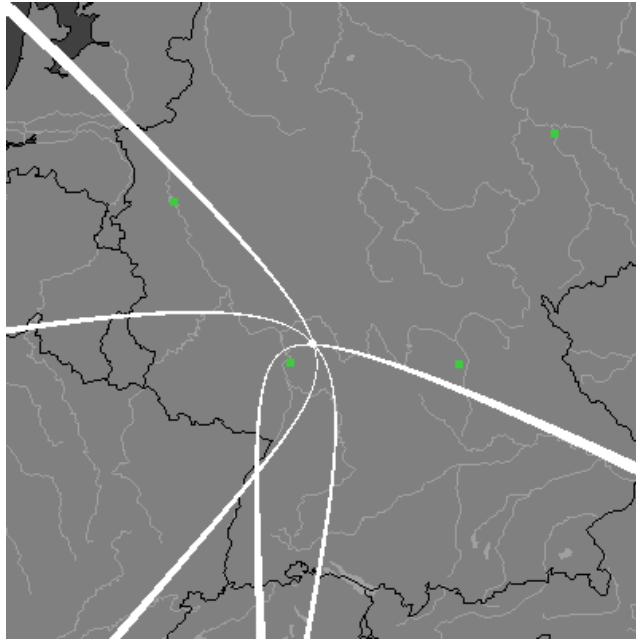

Figure 37: Three hyperbolic curves defined by the three time differences of four sites. The intersection uniquely defines the location of the source of the radio signal.

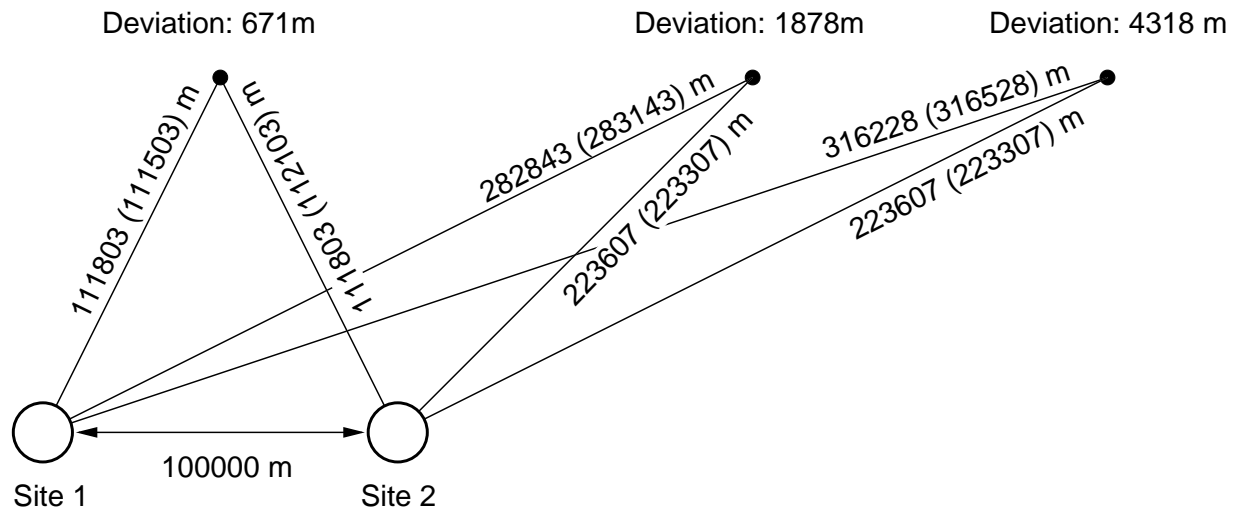

Figure 38: The deviations for an accuracy of  $\pm 1\mu S$ , which corresponds to a distance difference of 300m.

characteristic time stamp. This is not easy, because the outline of the signal changes when it travels over long distances. However, if the time stamps are not consistently assigned, the hyperbolic curves does not intersect in a common intersection point. The computations at our server are carried out in two steps. In the first step a starting point is computed using the method from [KS01]. After that a numerical method is used to minimize the sum of the squared distances to the hyperbolic curves. All computations are based on spherical

coordinates.

Figure 37 shows a comparison of lightning positions computed by blitzortung.org (yellow symbols) and Euclid.org (red Symbols).

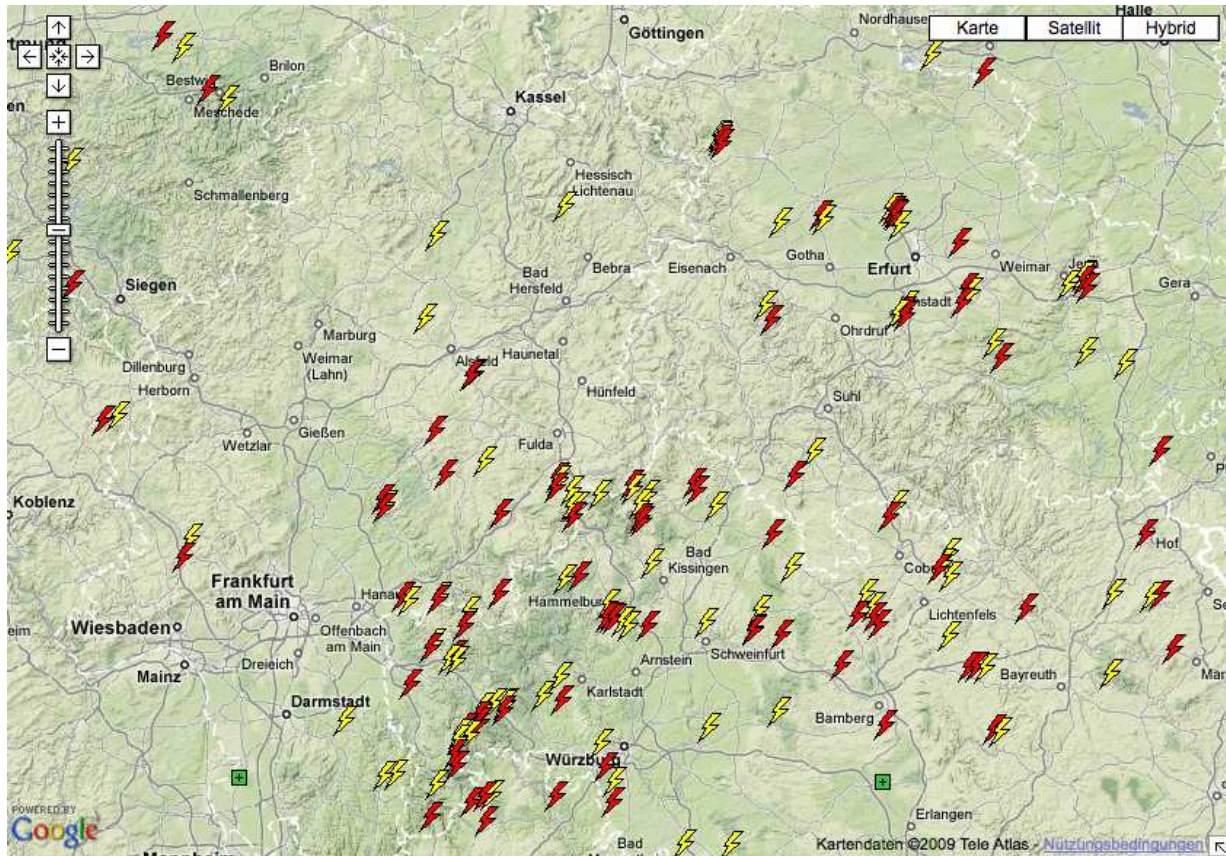

Figure 39: A comparison of lightning positions computed by blitzortung.org (yellow symbols) and Euclid.org (red Symbols).

## References

- [KS01] W.J. Koshak and R.J. Solakiewicz. TOA Lightning Location Retrieval on Spherical and Oblate Spheroidal Earth Geometries. *Journal of Atmospheric and Oceanic Technology*, 18(2):187-199, 2001.
- [BSL09] H.D. Betz, U. Schumann, and P. Laroche (Eds.) Lightning: Principles, Instruments and Applications. *Springer Verlag*, 2009.

## 8 Prices and how to get the material

We only offer the PCBs and the programmed micro controller. We do not offer completely assembled kits. You have to gather all the necessary material by yourself, but we will try to help you to find a vendor where you can buy all the parts. In exceptional cases, we deliver complete kits (not assembled) if the parts are difficult to get in certain countries. In this case, we sell everything at cost prices without profit-making intentions, and we only sell parts to persons who promise to take part to the network. You will receive bank account information on request.

To get an overview of the costs for assembling such a system, we state here some prices. These are approximate prices of traders in Germany. Clearly, the prices will differ from country to country, but a rough orientation seems to be always interesting for an estimation of the total costs. In the listed example the price for both complete kits in Germany at the time this document is written is

$$28,85 \text{ Euro} + 50,25 \text{ Euro} = 79,10 \text{ Euro}.$$

Our prices for shipping from Germany are

6,90 Euro	with DHL	within Germany,
16,05 Euro	with Deutsche Post	to European countries, and
26,05 Euro	with Deutsche Post	to all over the world.

You additionally need a GPS device providing a 1PPS output, and a VLF antenna. Suitable ferrite rod antennas can be obtained from [www.sfericsempfang.de](http://www.sfericsempfang.de), order number SKS 200 BL (21 Euro each).

Part	approximate Price
Semiconductors	
4 × NE5534	4 × 0,40 €
1 × 1N4001, rectifier diode	1 × 0,05 €
1 × LED, 5mm, red	1 × 0,10 €
Σ	1,75 €
Capacities	
4 × 470μF, 16V, electrolytic 8x11mm, pitch 3.5mm	4 × 0,10 €
11 × 100nF, ceramic, multi-layer, pitch 2.5mm	11 × 0,10 €
2 × 22nF, ceramic, multi-layer, pitch 2.5mm	2 × 0,10 €
6 × 10nF, ceramic, multi-layer, pitch 2.5mm	6 × 0,10 €
2 × 1nF, ceramic, multi-layer, pitch 2.5mm	2 × 0,10 €
4 × 220pF, ceramic, multi-layer, pitch 2.5mm	4 × 0,10 €
Σ	2,80 €
Inductors	
3 × 470μF, ferrite, pitch 5mm	3 × 0,50 €
Σ	1,50 €
Resistors	
2 × 1m, metal film	2 × 0,10 €
8 × 330k, metal film	8 × 0,10 €
2 × 50k, trimmer, type Y	2 × 0,45 €
2 × 47k, metal film	2 × 0,10 €
2 × 2.2k, metal film	2 × 0,10 €
3 × 1k, metal film	3 × 0,10 €
2 × 680, metal film	2 × 0,10 €
Σ	2,70 €
Further material	
1 × PCB 5, Version 3	1 × 10,00 €
1 × RJ45 jack, 8 ways, shielded	1 × 0,60 €
1 × DC jack, PCB, 2.1mm	1 × 0,15 €
1 × Jack socket, PCB, 3,5mm	1 × 0,15 €
1 × Terminal block, PCB, 4 way, pitch 5mm	1 × 0,40 €
4 × IC socket, 8 ways	4 × 0,20 €
1 × Power Supply, 12V, stabilized	1 × 6,00 €
1 × Stereo Headphone, 3,5mm	1 × 2,00 €
Σ	20,10 €
Σ	<u>28,85 €</u>

Table 12: Approximate prices of the parts for the pre-amplifier including the power supply.

Part	approximate Price
<b>Semiconductors</b>	
1× ATmega644P-20PU	1 × 6,30 €
2× AD7813	2 × 8,85 €
1× LM339	1 × 0,15 €
1× MAX232	1 × 0,45 €
1× 78S05	1 × 0,40 €
3× 1N4001, rectifier diode	3 × 0,05 €
1× LED, 5mm, red	1 × 0,10 €
1× LED, 5mm, yellow	1 × 0,10 €
1× LED, 5mm, green	1 × 0,10 €
1× LED, 5mm, blue	1 × 0,30 €
∑	25,75 €
<b>Capacities</b>	
2 × 470μF, 16V, electrolytic 8x11mm, pitch 3.5mm	2 × 0,10 €
1 × 100μF, 16V, electrolytic 5x11mm, pitch 2.5mm	1 × 0,10 €
6 × 4.7μF, 100V, electrolytic 5x11mm, pitch 2.5mm	6 × 0,10 €
7 × 100nF, ceramic, multi-layer, pitch 2.5mm	7 × 0,10 €
2 × 15pF, ceramic, multi-layer, pitch 2.5mm	2 × 0,10 €
∑	1,80 €
<b>Inductors</b>	
1 × 470μF, ferrite, pitch 5mm	1 × 0,50 €
∑	0,50 €
<b>Resistors</b>	
10 × 10k, metal film	10 × 0,10 €
2 × 2.2k, metal film	2 × 0,10 €
2 × 1k, metal film	2 × 0,10 €
2 × 330, metal film	2 × 0,10 €
∑	1,60 €
<b>Further material</b>	
1× PCB 6, Version 3	1 × 10,00 €
1× Crystal, 20MHz	1 × 0,20 €
1× RJ45 jack, 8 ways, shielded	1 × 0,60 €
1× DC jack, PCB, 2.1mm	1 × 0,15 €
1× Straight Header Connector jack, 6 ways	1 × 0,10 €
3× Header Connector plug, 6 ways	3 × 0,25 €
1× Pin header, 40 pins	1 × 0,25 €
8× Jumper	8 × 0,10 €
2× Mini switch	2 × 0,15 €
1× Sub-D plug, PCB, 9 ways	1 × 0,30 €
1× Cooling device, TO220	1 × 0,50 €
1× IC socket, 40 ways	1 × 0,50 €
3× IC socket, 16 ways	3 × 0,30 €
1× IC socket, 14 ways	1 × 0,25 €
1× Connection cable, SUB-D, 9 ways	1 × 2,00 €
1× Network cable, RJ45/RJ45, 5m, CAT5	1 × 3,00 €
∑	20,60 €
∑	50,25 €

Table 13: Approximate prices of the parts for the evaluation board.